

Door and Window Elements
 门窗组件







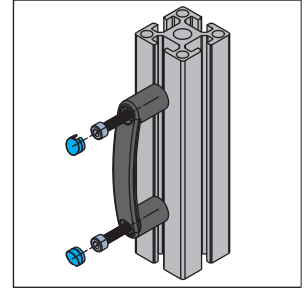
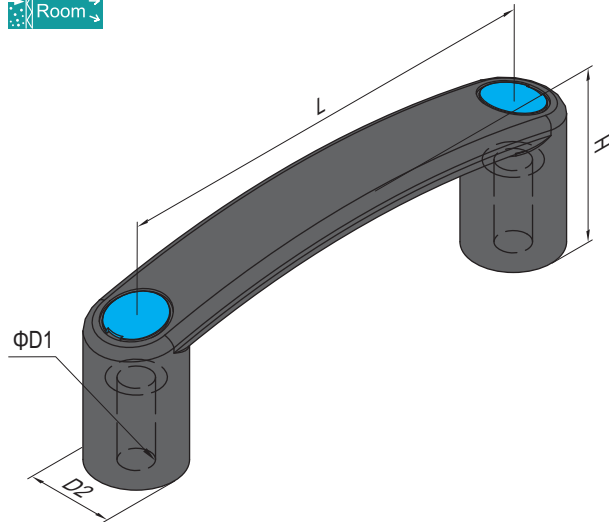

Handle

























把手

Material and Color: black PA6 Cap Color: blue and black

材质和颜色: 尼龙6 黑色 扣盖颜色: 蓝色BE/黑色BK



CA	Fastening Set	CB	Fastening Set	CD	Fastening Set	CE	Fastening Set
	M5x25 Bolt zinc plated		M6x25 Bolt zinc plated		M8x25 Bolt zinc plated		M8x30 Bolt zinc plated
	M5 T Nut nickel plated		M6 T Nut nickel plated		M8 T Nut nickel plated		M8 T Nut nickel plated

Application 应用	Description 产品描述	L (mm)	H (mm)	D1 (mm)	D2 (mm)	Fastening Set 紧固组件	Cap Color 扣盖颜色	Mass 重量 (g)	Part No. 订购编号
PG15/20 	PA6 Handle-90 (pcs)/尼龙把手-90 (单个供货)	90	36	6.5	18			23	7.11.90.06.BE
	PA6 Handle-90 (set)/尼龙把手-90 (成套供货)					2xCA		41	7.11.90.06.BE.ST
	PA6 Handle-90 (pcs)/尼龙把手-90 (单个供货)							23	7.11.90.06.BK
	PA6 Handle-90 (set)/尼龙把手-90 (成套供货)					2xCA		41	7.11.90.06.BK.ST
PG30 	PA6 Handle-90 (pcs)/尼龙把手-90 (单个供货)	90	36	6.5	18			23	7.11.90.08.BE
	PA6 Handle-90 (set)/尼龙把手-90 (成套供货)					2xCB		45	7.11.90.08.BE.ST
	PA6 Handle-90 (pcs)/尼龙把手-90 (单个供货)							23	7.11.90.08.BK
	PA6 Handle-90 (set)/尼龙把手-90 (成套供货)					2xCB		45	7.11.90.08.BK.ST
	PA6 Handle-120 (pcs)/尼龙把手-120 (单个供货)	120	40	8.5	25			45	7.11.120.08.BE
	PA6 Handle-120 (set)/尼龙把手-120 (成套供货)					2xCB		68	7.11.120.08.BE.ST
	PA6 Handle-120 (pcs)/尼龙把手-120 (单个供货)							45	7.11.120.08.BK
	PA6 Handle-120 (set)/尼龙把手-120 (成套供货)					2xCB		68	7.11.120.08.BK.ST
PG40 	PA6 Handle-120 (pcs)/尼龙把手-120 (单个供货)	120	40	8.5	25			45	7.11.120.10.04.BE
	PA6 Handle-120 (set)/尼龙把手-120 (成套供货)					2xCD		88	7.11.120.10.04.BE.ST
	PA6 Handle-120 (pcs)/尼龙把手-120 (单个供货)							45	7.11.120.10.04.BK
	PA6 Handle-120 (set)/尼龙把手-120 (成套供货)					2xCD		88	7.11.120.10.04.BK.ST
PG45/50/60 	PA6 Handle-120 (pcs)/尼龙把手-120 (单个供货)	120	40	8.5	25			45	7.11.120.10.06.BE
	PA6 Handle-120 (set)/尼龙把手-120 (成套供货)					2xCE		104	7.11.120.10.06.BE.ST
	PA6 Handle-120 (pcs)/尼龙把手-120 (单个供货)							45	7.11.120.10.06.BK
	PA6 Handle-120 (set)/尼龙把手-120 (成套供货)					2xCE		104	7.11.120.10.06.BK.ST