

Door and Window Elements
门窗组件

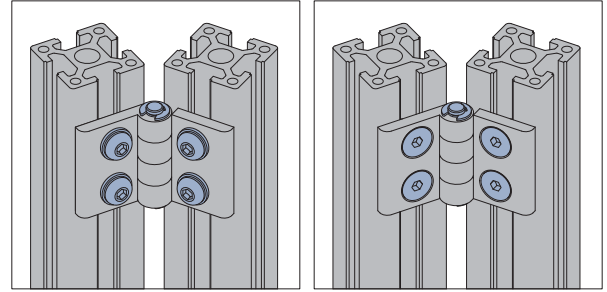

Hinge
合页

Material and Color: aluminum, nature anodized
材质和颜色: 铝合金 光亮氧化



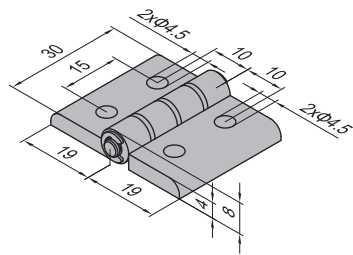





Hinge-Aluminum Through Hole
合页-铝合金-圆孔





PC	Fastening Set
	M4x10 Bolt zinc plated
	M4 Washer zinc plated
	M4 T Nut nickel plated

Description 产品描述	H1 (mm)	H2 (mm)	L1 (mm)	L2 (mm)	D1 (mm)	D2 (mm)	Fastening Set 紧固组件	Mass 重量 (g)	Part No. 订购编号
20/20 (pcs)/单个供货								15	7.23.20.20
20/20 (set)/成套供货							4xPC	29	7.23.20.20.ST

FH	Fastening Set
	M6x14 Bolt zinc plated
	M6 Washer zinc plated
	M6 T Nut nickel plated

FJ	Fastening Set
	M8x16 Bolt zinc plated
	M8 Washer zinc plated
	M8 T Nut nickel plated

FK	Fastening Set
	M8x20 Bolt zinc plated
	M8 Washer zinc plated
	M8 T Nut nickel plated

Hinge-Aluminum Through Hole
合页-铝合金-圆孔

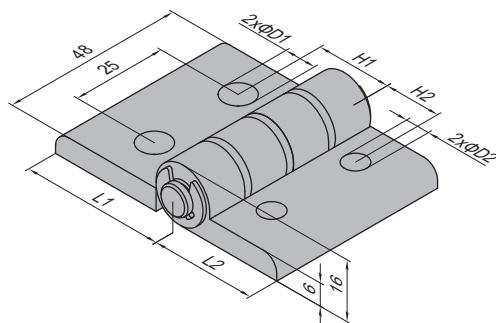

Description 产品描述	H1 (mm)	H2 (mm)	L1 (mm)	L2 (mm)	D1 (mm)	D2 (mm)	Fastening Set 紧固组件	Mass 重量 (g)	Part No. 订购编号
30/30 (pcs)/单个供货	15	15	28	28	6.5	6.5		71	7.23.30.30
30/30 (set)/成套供货	15	15	28	28	6.5	6.5	4xFH	99	7.23.30.30.ST
30/40 (pcs)/单个供货	20	15	38	28	8.5	6.5		76	7.23.30.40
30/40 (set)/成套供货	20	15	38	28	8.5	6.5	2xFH+2xFJ	124	7.23.30.40.ST
30/45 (pcs)/单个供货	22.5	15	38	28	8.5	6.5		76	7.23.30.45
30/45 (set)/成套供货	22.5	15	38	28	8.5	6.5	2xFH+2xFK	127	7.23.30.45.ST
40/40 (pcs)/单个供货	20	20	38	38	8.5	8.5		83	7.23.40.40
40/40 (set)/成套供货	20	20	38	38	8.5	8.5	4xFJ	151	7.23.40.40.ST
40/45 (pcs)/单个供货	22.5	20	38	38	8.5	8.5		83	7.23.40.45
40/45 (set)/成套供货	22.5	20	38	38	8.5	8.5	2xFJ+2xFK	156	7.23.40.45.ST
45/45 (pcs)/单个供货	22.5	22.5	38	38	8.5	8.5		83	7.23.45.45
45/45 (set)/成套供货	22.5	22.5	38	38	8.5	8.5	4xFK	161	7.23.45.45.ST