

Connecting Elements
连接件





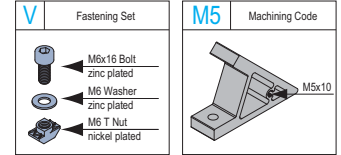
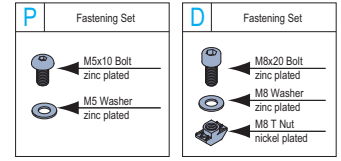
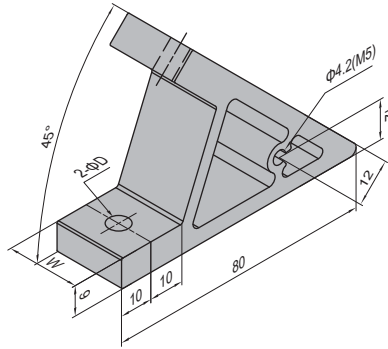

Angle Profile Bracket
挤压角铝

Material: aluminium, anodized (cutting end not anodized)
材质: 铝合金, 表面阳极氧化 (切面无处理)



80x80x9-45°



Application 应用	Description 产品描述	D (mm)	W (mm)	Fastening Set 紧固组件	Machining Code 加工代码	Mass 重量 (g)	Part No. 订购编号
PG30 30mm 	80-30-30 (pcs/单个供货)	7	22			68	3.31.80.30.30
	80-30-30 (set/成套供货)	7	22	2xV		91	3.31.80.30.30.ST
	80-30-30 (M5/加工供货)	7	22		M5	68	3.31.80.30.30.M5
	80-30-30 (M5 set/成套加工供货)	7	22	2xV+1xP	M5	93	3.31.80.30.30.M5.ST
PG40 40mm 	80-40-40 (pcs/单个供货)	9	30			89	3.31.80.40.40
	80-40-40 (set/成套供货)	9	30	2xD		135	3.31.80.40.40.ST
	80-40-40 (M5/加工供货)	9	30		M5	89	3.31.80.40.40.M5
	80-40-40 (M5 set/成套加工供货)	9	30	2xD+1xP	M5	137	3.31.80.40.40.M5.ST
PG40 60mm 	80-40-60 (pcs/单个供货)	9	50			151	3.31.80.40.60
	80-40-60 (set/成套供货)	9	50	2xD		197	3.31.80.40.60.ST
	80-40-60 (M5/加工供货)	9	50		M5	151	3.31.80.40.60.M5
	80-40-60 (M5 set/成套加工供货)	9	50	2xD+1xP	M5	199	3.31.80.40.60.M5.ST
PG45 45mm 	80-45-45 (pcs/单个供货)	9	35			105	3.31.80.45.45
	80-45-45 (set/成套供货)	9	35	2xD		151	3.31.80.45.45.ST
	80-45-45 (M5/加工供货)	9	35		M5	105	3.31.80.45.45.M5
	80-45-45 (M5 set/成套加工供货)	9	35	2xD+1xP	M5	153	3.31.80.45.45.M5.ST
PG45 60mm 	80-45-60 (pcs/单个供货)	9	50			151	3.31.80.45.60
	80-45-60 (set/成套供货)	9	50	2xD		197	3.31.80.45.60.ST
	80-45-60 (M5/加工供货)	9	50		M5	151	3.31.80.45.60.M5
	80-45-60 (M5 set/成套加工供货)	9	50	2xD+1xP	M5	199	3.31.80.45.60.M5.ST
PG50 50mm 	80-50-50 (pcs/单个供货)	9	50			120	3.31.80.50.50
	80-50-50 (set/成套供货)	9	50	2xD		166	3.31.80.50.50.ST
	80-50-50 (M5/加工供货)	9	50		M5	120	3.31.80.50.50.M5
	80-50-50 (M5 Set/成套加工供货)	9	50	2xD+1xP	M5	168	3.31.80.50.50.M5.ST
PG60 60mm 	80-60-60 (pcs/单个供货)	9	50			151	3.31.80.60.60
	80-60-60 (set/成套供货)	9	50	2xD		197	3.31.80.60.60.ST
	80-60-60 (M5/加工供货)	9	50		M5	151	3.31.80.60.60.M5
	80-60-60 (M5 Set/成套加工供货)	9	50	2xD+1xP	M5	199	3.31.80.60.60.M5.ST